

TREVIL®



Treviflex - Planoflex



Treviflex - Planoflex

ENG

Series of blowing and vacuum tables, adjustable in height, available in 20 models with or without boiler.

SPECIFICATIONS

- Height adjustment of ironing surface from 80 to 100 cm.
- Available for use with point to the right or point to the left.
- Independent vacuum and blowing regulation.
- Surface heating element with independent switch.

OPTIONS

- Lighting group with or without iron support.
- Vacuum and blowing sleeve bucks.
- Pivoting iron support for use with point to the right.

ITA

Tavolo aspirante e soffiante regolabile in altezza e modulare, disponibile in 20 modelli con o senza caldaia.

CARATTERISTICHE

- Regolazione dell'altezza di stiratura da 80 a 100 cm.
- Possibilità di stirare da ambo i lati.
- Regolazioni separate aspirazione e soffiaggio.
- Stiratura con tavolo freddo o caldo.

ACCESSORI DISPONIBILI

- Gruppo illuminazione con o senza bilanciatore.
- Forme stiramaniche aspiranti e soffianti.
- Supporto ferro girevole per stiratura con punta a destra.

ESP

Mesa soplante y aspirante ajustable en altura, disponible en 20 modelos con o sin caldera.

CARACTERÍSTICAS

- Regulación de la altura del plato de 80 a 100 cm.
- Posibilidad de planchar a la derecha y/o a la izquierda.
- Regulación independiente del soplado y de la aspiración.
- Plato frío o caliente.

OPCIONAL

- Grupo de iluminación con o sin soporte aéreo para plancha.
- Brazo plancha-mangas con soplado y aspiración.
- Soporte para planchado a la derecha.

FRA

Table aspirante et soufflante réglable en hauteur et modulable, disponible en 20 modèles avec ou sans chaudière.

CARACTÉRISTIQUES

- Réglage de la hauteur de repassage de 80 à 100 cm.
- Possibilité de repassage sur les deux côtés.
- Réglages indépendants de l'aspiration et de la soufflerie.
- Repassage sur table à froid ou chauffe.

ACCESSOIRES DISPONIBLES

- Groupe lumière avec ou sans suspension du fer.
- Jeannettes manche aspirantes et soufflantes.
- Support de fer pivotant pour repassage avec pointe à droite.

DEU

Blas-Saug-Bügeltisch mit höhenverstellbarem Tischblatt, verfügbar in 20 versch. Ausführungen, mit oder ohne integriertem Dampferzeuger.

CHARAKTERISTIK

- Höhenverstellbares Tischblatt von 80 bis 100 cm.
- Bügeln mit Spitze rechts oder links.
- Separate Blas-Saug-Regulierung.
- Bügelfläche unbeheizt.

OPTIONALS

- Support mit Beleuchtung, mit oder ohne Gewichts.
- Ausgleicher für die Bügeleisenaufhängung.
- Absaugende und blasen de Ärmelbüglerform.
- Schwenkbare Bügeleisenabstellfläche für Bügeltisch mit Spitze rechts.



Treviflex - Planoflex

Independent adjustment of suction and blowing strength
 Regolazione indipendente della forza di aspirazione e soffiaggio
 Regulación independiente de la intensidad de soplado y aspiración
 Réglage indépendant de l'intensité de soufflante et d'aspiration
 Unabhängige Einstellung der Gebläse- und Ansaugstärke

Adjustable in height without help from another person and without tools
 Altezza regolabile autonomamente e senza attrezzi
 Ajustable individualmente en altura, sin herramientas
 Hauteur réglable indépendamment et sans outils
 Höhe, unabhängig verstellbar ohne Werkzeuge

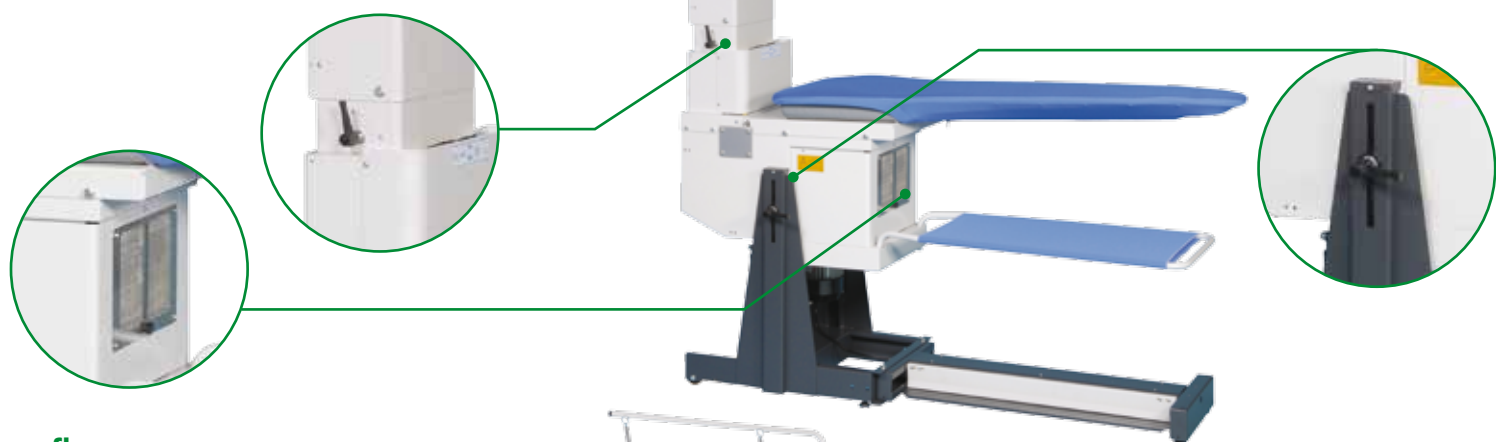

Planoflex

With pump-fed built-in boiler
 Con caldaia incorporata alimentata automaticamente
 Con caldera incorporada con alimentación automática
 Avec chaudière incorporée à alimentation automatique
 Mit eingebauter Kessel mit automatischer Zufuhr

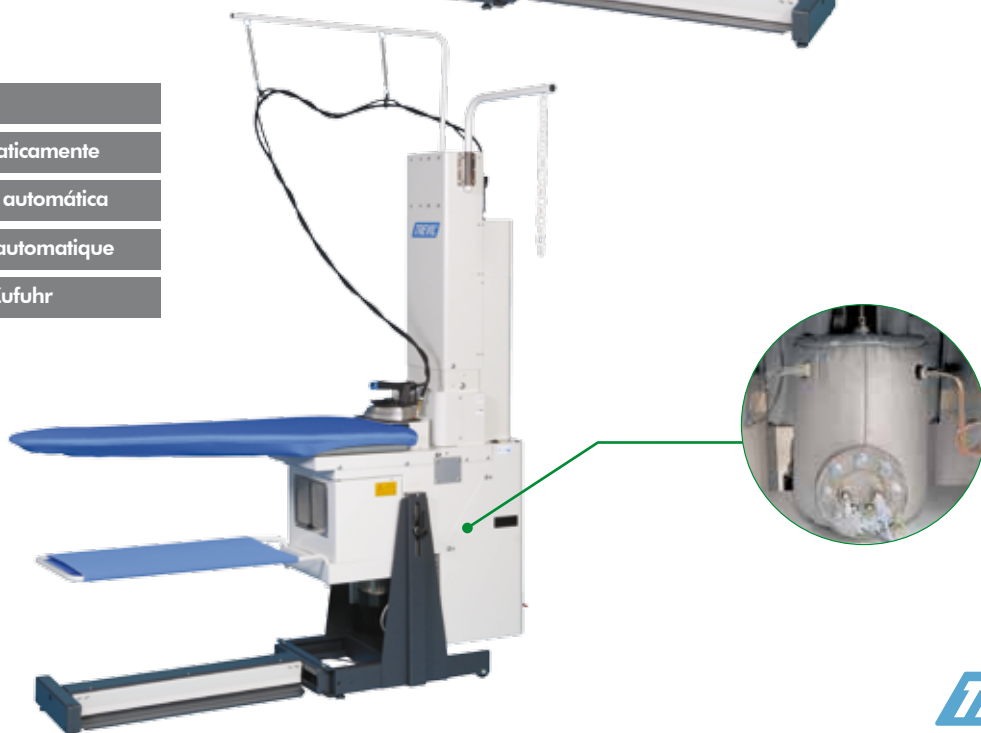



+

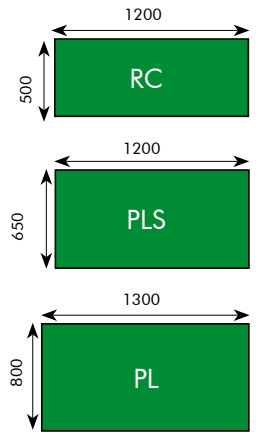
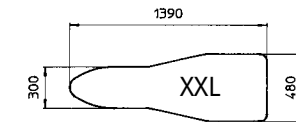
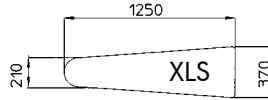
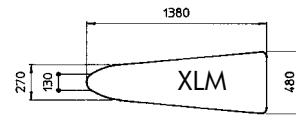
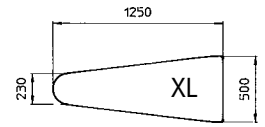

Shapes - Forme - Mesas - Formes - Fläche



B010
B011



X309
X306



F021



X100



B012
B013



X309
X310



S208
S209

Accessories - Accessori - Accesorios - Accessoires - Zubehör

TECHNICAL SPECIFICATIONS	DATI TECNICI	DATOS TECNICOS	DONNES TECHNIQUES	TECHNISCHE DATEN	TREVFLEX	PLANOFLEX
Electrical specifications	Alimentazione	Alimentación eléctrica	Courant	Elektroanschluss	400V 50Hz*	400V 50 Hz*
Water inlet	Alimentazione acqua	Alimentación agua	Alimentation eau	Wasseranschluss	-	Ø 16 mm
Boiler exhaust	Scarico caldaia	Salida caldera	Sortie chaudière	Kessel-Anschluss	-	1/2"
Steam pressure	Pressione vapore	Presion del vapor	Pression vapeur	Dampfdruck	3 kPa (3 bar)	3 kPa (3 bar)
Boiler heating element	Resistenza caldaia	Resistencia calderin	Résistance chaudière	Heizgruppen	-	4 kW, 5l
Pump	Motore pompa	Motor de la bomba	Moteur pompe	Pumpenmotor	-	0,45 kW
Air motor	Motore ventilatore	Motor de aspiracion	Moteur vacuum	Absaugventilator	0,55 kW 3ph	0,55 kW 3ph
Iron heating element	Resistenza ferro	Resistencia de la plancha	Résistance fer	Bügeleisen-Heizwiderstand	-	0,8 kW
Table heating element	Resistenza tavolo	Resistencia platò	Résistance de table	Tischheizung	0,4÷0,8 kW	0,4÷0,8 kW
UTILITY SHAPES	FORME UNIVERSALI	MESAS UNIVERSALE	FORMES UNIVERSELLES	UNIVERSALER FLÄCHE		
Overall dimensions	Ingombro macchina	Dimensiones	Encombrement	Abmessungen	135x50x80÷100 cm	155x50x80÷100 cm
Net weight	Peso netto	Peso neto	Poids net	Nettogewicht	100 kg	130 kg
Gross weight	Peso lordo	Peso bruto	Poids brut	Bruttogewicht	120 kg	150 kg
Packing dimens.	Dimensione imballo	Dimens. embalaje	Dimens. emballage	Verpackungsmaße	180x60x114 cm	180x60x114 cm
SQUARE SHAPES	FORME RETTANGOLARI	MESAS RECTANGULA	FORMES RECTANGULAIRES	RECHTEKIGER FLÄCHE		
Overall dimensions	Ingombro macchina	Dimensiones	Encombrement	Abmessungen	110x130x80÷100 cm	130x130x80÷100 cm
Net weight	Peso netto	Peso neto	Poids net	Nettogewicht	130 kg	150 kg
Gross weight	Peso lordo	Peso bruto	Poids brut	Bruttogewicht	155 kg	175 kg
Packing dimens.	Dimensione imballo	Dimens. embalaje	Dimens. emballage	Verpackungsmaße	140x140x114 cm	140x140x114 cm
*Other on request	* Altri a richiesta	*Otros por petición	*Autres sur demande	*Andere auf Anfrage		
Subject to modification without notice	Con riserva di modifica senza preavviso	Con reserva de modificación sin previo aviso	Sous réserve de modification sans préavis	Änderungen vorbehalten		



Trevil s.r.l.
Via Copernico, 1 - Pozzo d'Adda (MI) - Italy - 20060
Tel +39 02 9093141 - Fax +39 02 90968202
www.trevil.com - info@trevil.com